

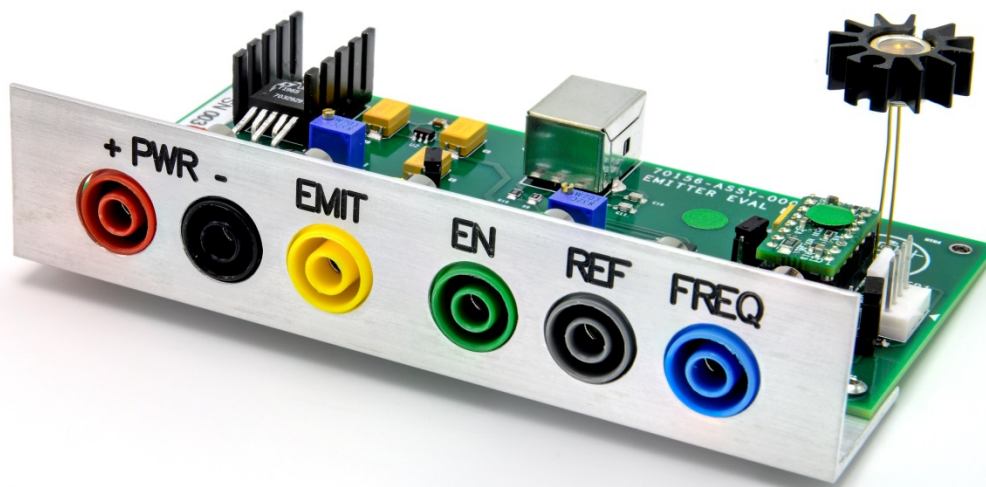

PIRE^{PLUS} High Speed Emitter Evaluation Board and Kit

40801 User Manual

Revision B



PIRE PLUS Evaluation Board and Software User Manual Revision B

NOTICE

The information contained in the document is believed to be accurate. No responsibility is assumed for any errors or inaccuracies. OptoDiode reserves the right to make changes, without notice, to its products and documentation to improve accuracy, performance, reliability and quality. OptoDiode does not assume any liability for use of any product described within this document or its application. No license regarding patent rights nor rights to manufacture OptoDiode's products are conveyed nor transferred to users of these products.

Table of Contents

I.	Applicability	1
II.	Definitions	2
III.	Description, Features, and Modes of operation	
	A. Overall Description	3
	B. Product Overview and Features	3
	C. Hardware Mode Summary (J13 Jumper in place)	5
	D. Software Mode (J13 Jumper removed)	6
IV.	Optimizing the signal output of the emitter	7
V.	Mechanical drawing.....	8
VI.	Ordering information.....	8
VII.	Software Support	8

I. APPLICABILITY

This manual provides information for 40801 evaluation board, which is for evaluation of the high speed emitter and its driver. This kit is known as the Pire Plus

40801 evaluation board and kit includes, an emitter driver board, a high speed emitter model SPF 220-5M2 high speed IR emitter with TO-5 heat sink.

II. DEFINITIONS

HW = Hardware Mode controlled by hardware on board

SW = Software controlled on a PC and connected to the Evaluation Board via USB cable

III. DESCRIPTION, FEATURES, AND MODES OF OPERATION

A. Overall Description

The Evaluation Board and Kit provides a convenient means to operate and test the SPF220-5M2 (P/N 40101) emitter's performance and the 14 pin DIP package Emitter Driver Board, which is designed to pulse it. A heat sink is included. The user needs solder the emitter in to the evaluation board emitter – and + plated holes, directly or with wires. It provides options for using hardware-based controls or a software interface. The hardware interface allows controlling the frequency of the Emitter Driver Board via an external voltage or an on-board potentiometer.

The Evaluation Board also comes with a simple software driver and app that provides a simple User Interface via a USB interface.

B. Product Overview and Features

Front Panel connections

**PIRE PLUS Evaluation Board and Software
User Manual Revision B**

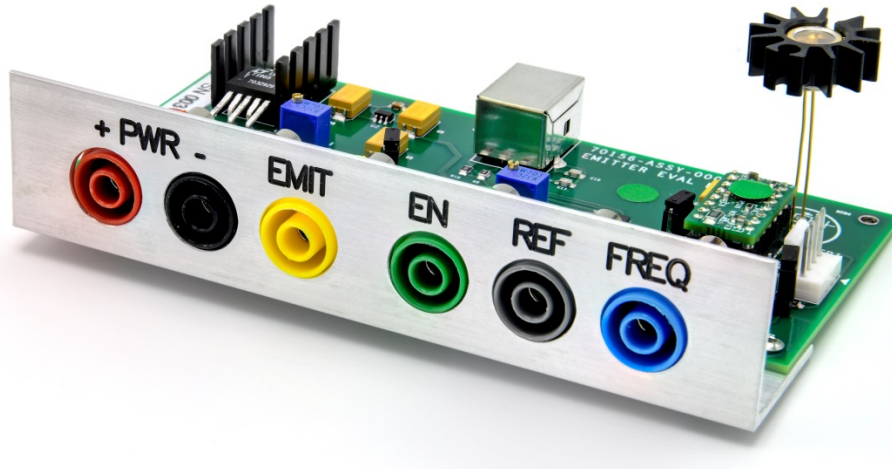

Front Panel Connection	Description
+ PWR -	Main power Jacks +4.5V to +5.5V When jumper J3 is in place this input also powers the emitter from the internal regulator. Be sure to use a power supply that can handle the 1 amp pulse load to ensure proper operation of the emitter driver.
EMIT	External Emitter Power Input Jack Use only when jumper J3 is removed The DC or average supply current must not exceed 1A through the emitter
EN	Emitter Enable for Hardware Mode Jack When J13 is in place a When open circuit or grounded the emitter drive is off. <0.7V = output disabled >2.4V = output enabled Absolute max input voltage: +5V
REF	Emitter Power Pulse Monitor Output Jack Output waveform displays represents the drive pulsing of the emitter. When low the emitter is being supplied current.
FREQ	Input Jack When J9 and J13 are in place the driver frequency is controlled by the analog voltage on this jack. 0V = 1Hz, 2.4V = 200Hz Absolute max input voltage: +5V

Figure 1 below shows the simple block diagram of the Evaluation Board. **Figure 2** is a photograph of the Eval board. The controller provides a standardized interface for controlling the drive current and/or energy to the emitter. The driver is a fixed pulse width, variable frequency circuit operated to be compatible with driving thermal devices. The pulse width can be varied only when under software control.

The system contains protection against accidental power supply reversal. It also provides on-board regulators to protect against accidental over-voltage on the power supplies.

PIRE PLUS Evaluation Board and Software

User Manual Revision B

Figure 1 - Block Diagram

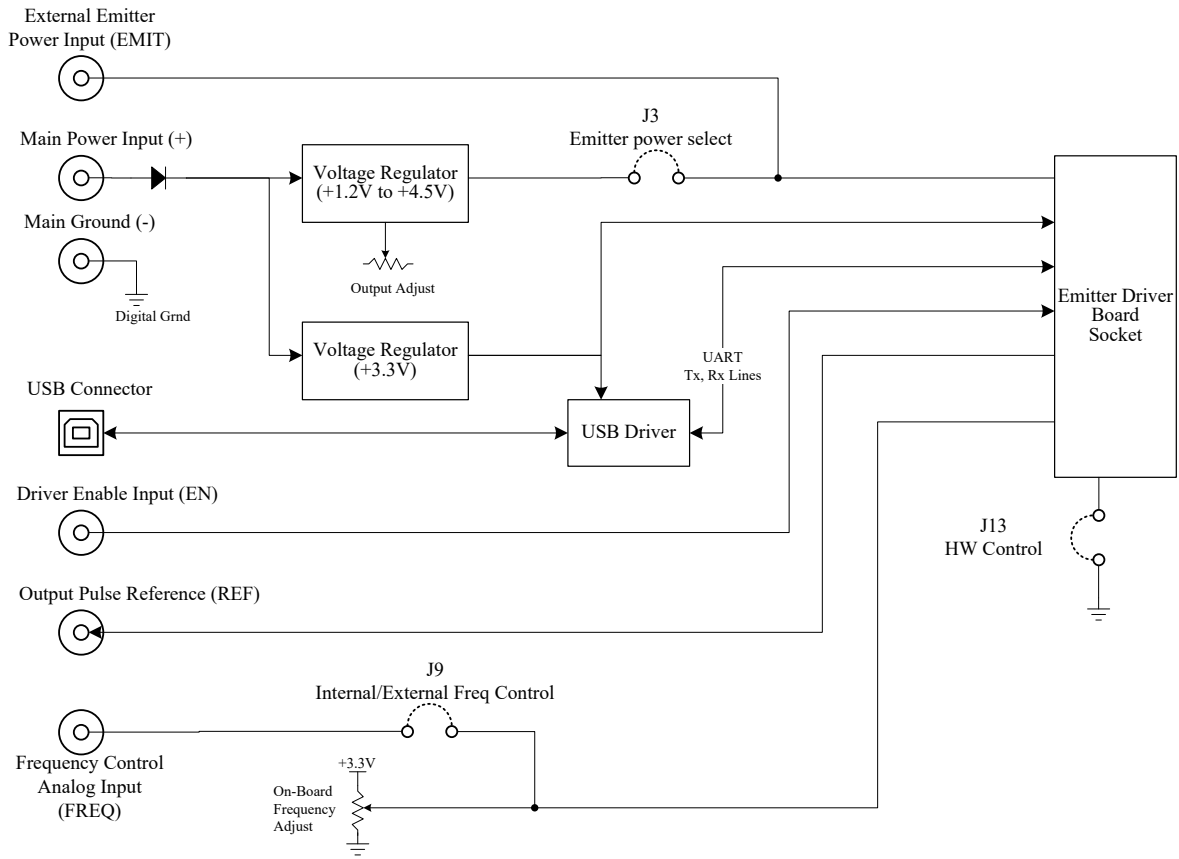

PIRE PLUS Evaluation Board and Software User Manual Revision B

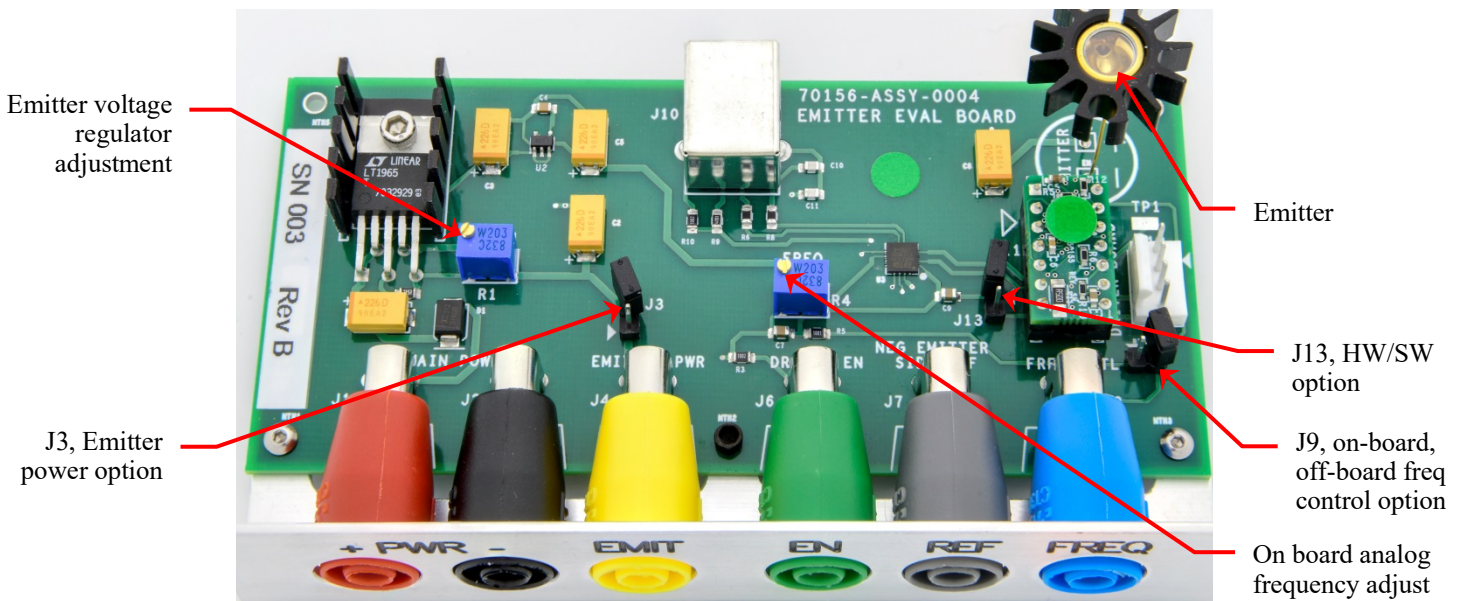

Figure 2 - Jumpers and Potentiometers

Jumpers provide the following options / functionality:

- ◆ Jumper J3 - Provides options for powering the emitter.
J3 in place: on-board voltage regulator whose output is set by a R1 potentiometer (1.2V to 4.5V).
J3 removed: banana jack ("EMIT") is used to power the emitter from an external power supply.
- ◆ Jumper J9 - Provides options for setting the drive frequency when in hardware mode.
J9 in place: voltage on banana jack ("FREQ") controls the frequency (0 to 2.4V corresponds to 1Hz to 200 Hz). The analog drive to FREQ must be able to sink or source a minimum of 3.3mA.
J9 removed: on-board R4 potentiometer controls the frequency.
- ◆ Jumper J13- Provides options for controlling the driver via HW or USB interface.
J13 in place: Hardware mode, frequency is controlled by on-board potentiometer or external voltage ("FREQ" jack), the pulse width is fixed at 2300us. If the pulse width was set while in software mode, changing to HW mode will change the pulse width back to 2300us.
J13 removed: Software mode, driver is controlled via the Software interface (frequency and pulse width can be adjusted). Pulse width can be varied from 100us to 3000us. Removing J13 will disable the emitter drive if the drive was enabled while in HW mode.

Regardless of mode, the USB port can be used to read the present frequency, pulse width, and average current.

C. Hardware Mode Summary (J13 Jumper In)

The pulse width supplied to the emitter is not adjustable in hardware mode and is set at 2.3 ms. The enable input is active and will disable the emitter supply pulses when held low or not connected to a logic high. Jumper J9 selects between on board frequency control with R4 and DC voltage external frequency control input jack. Jumper J3 selects between on board emitter power control with R1 and the external emitter supply input jack. The emitter can be over power by the customer when using the external emitter supply option. The customer must keep the DC or average current below 1A.

PIRE PLUS Evaluation Board and Software User Manual Revision B

D. Software Mode (J13 Jumper Out)

For driver and software installation see read me file on USB flash drive supplied with the evaluation kit, which contains the drivers and software.

The proper sequence to execute is to power up the Evaluation Board and then start the SW application. This app can be used regardless of the jumper setting (J13).

When started the app will attempt to automatically locate the Evaluation Board. If the "USB Status" indicator does not turn green (this may take a few seconds), try recycling power and restarting the app.

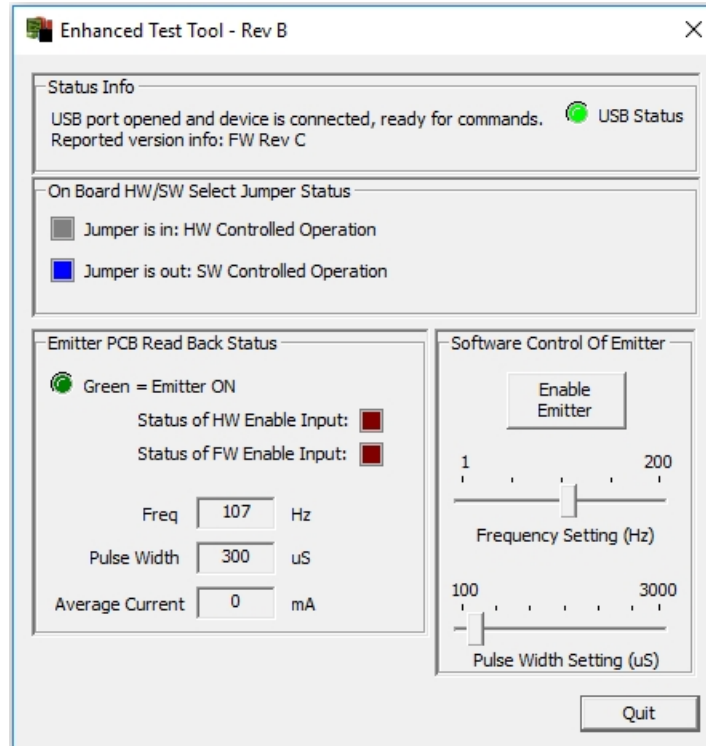

Figure 3 - SW Screen Shot

When J13 jumper is out, the buttons under "Software Control of Emitter" will be enabled allowing you to turn the emitter on/off, set the frequency and set the pulse width.

The default frequency is 180 Hz and the default pulse width is 2.3ms. The sliders can be moved back and forth to adjust the frequency and pulse width of the power to the emitter. To adjust the sliders the click mouse button and hold moving to the desired position and letting it go. The frequency or pulse width will be updated. If using the emitter voltage regulator adjustment potentiometer R1, it can be adjusted to give additional control of the power supplied to the emitter. The same can be done with an external drive supply. Average current is displayed in the box below the Freq and Pulse Width boxes. This average current must not exceed 1000 mA. See section D, optimizing the signal output of the emitter.

IV. OPTIMIZING THE SIGNAL OUTPUT OF THE EMITTER

PIRE PLUS Evaluation Board and Software User Manual Revision B

The power amplitude, pulse width, and frequency are adjusted to optimize the output of the emitter. Below are scope shots of two different pulse widths. The frequency and pulse amplitude of the driver are held constant and the pulse width with only been adjusted. Channel 1 is the output of the emitter measured with a PbSe detector and channel 2 is the emitter driver pulse REF monitor output. Note the differences in output amplitude between the narrow and wider pulse scopes. The narrower driver pulse gives less time for the element to heat up, but it allows more time for it to cool off. The wider driver pulse gives more time for the element to heat up and less time for it to cool off. The percentage modulation depth is lower with the wider pulse than the narrower pulse, but the output intensity is much higher. This is because the element is heating up more with the wider pulse. This wider pulse makes the filament much hotter, increasing its output. In addition, the hotter filament cools off much faster, which keeps a good modulation depth resulting in a higher output swing. The other additional benefit of the wider pulse is that the color temperature c. The software's frequency and pulse width sliders make it easy find the optimal pulse width for a frequency.

The narrower pulse width (channel 1 output of emitter, channel 2 driver pulse)
Note: that the intensity is lower but its percent modulation depth is higher

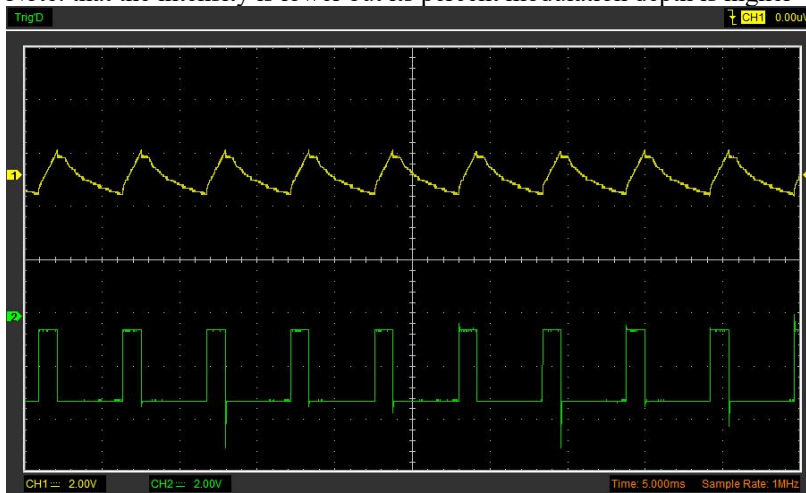

The longer pulse width (channel 1 output of the emitter, channel 2 driver pulse)
Note: that the intensity is higher but its percent modulation depth is less

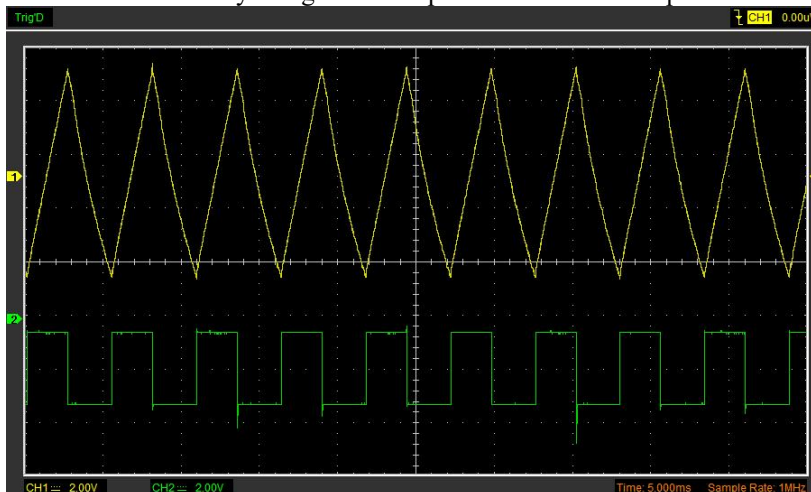

PIRE^{PLUS} Evaluation Board and Software User Manual Revision B

V. MECHANICAL DIMENSIONS

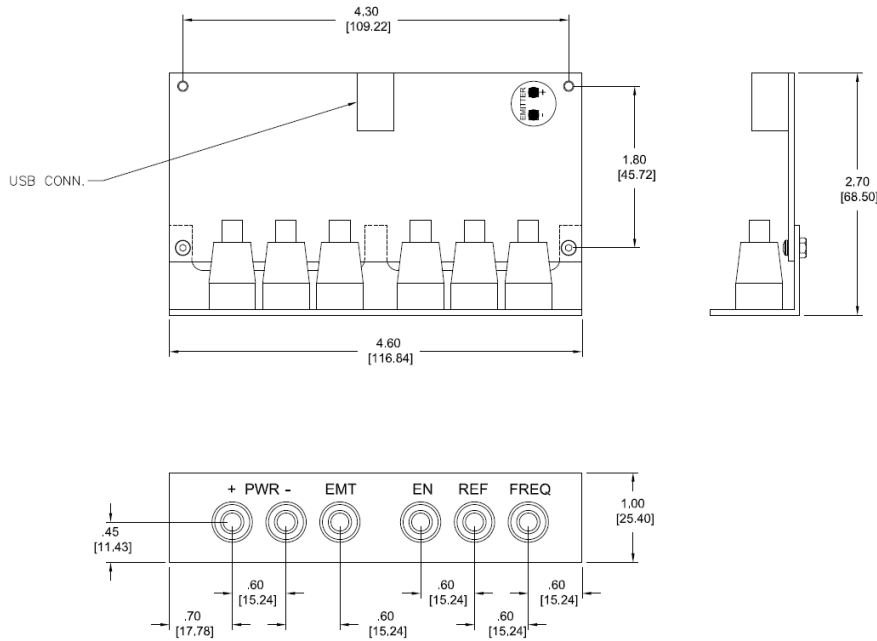

VI. ORDERING INFORMATION

High Speed Emitter in TO5 Package with Sapphire Window Model Number: SPF220-5M2 (P/N 40101)

High Speed Emitter with Heatsink Model Number: SPF220-5M2H (P/N 40800)

Evaluation Board with emitter Kit Model Number: PIRE^{PLUS} (P/N 40801)
(Kit includes a SPF220-5M2 Emitter with heatsink)

VII. SOFTWARE SUPPORT

Support@optodiode.com